

KVM OVER IP

IP Remote USB

Using USB devices with WEYTEC KVM solutions

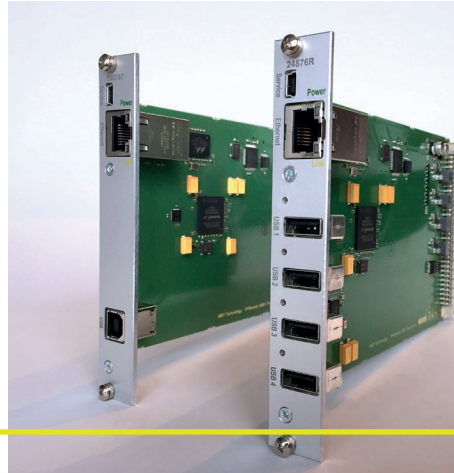

WHY WEYTEC

USB across multiple geographical locations and network segments (OSI layer 3)

WEYTEC IP Remote USB provides a transparent USB channel for devices such as hard disks, flash drives, fingerprint and card readers, audio devices, webcams and more. In combination with a WEYTEC distributionPLATFORM, USB connections can be switched between desks and PCs.

- Extend any USB device over standard IP networks
- Transparent USB (no drivers required)
- USB 2.0 Hi-Speed
- Switchable, in combination with a WEYTEC distributionPLATFORM (WDP)
- Can be integrated into existing WEYTEC systems
- Works across multiple sites / network segments
- Built-in to WEYTEC KVM chassis and/or boxes

Application example: Point-to-Point Environment

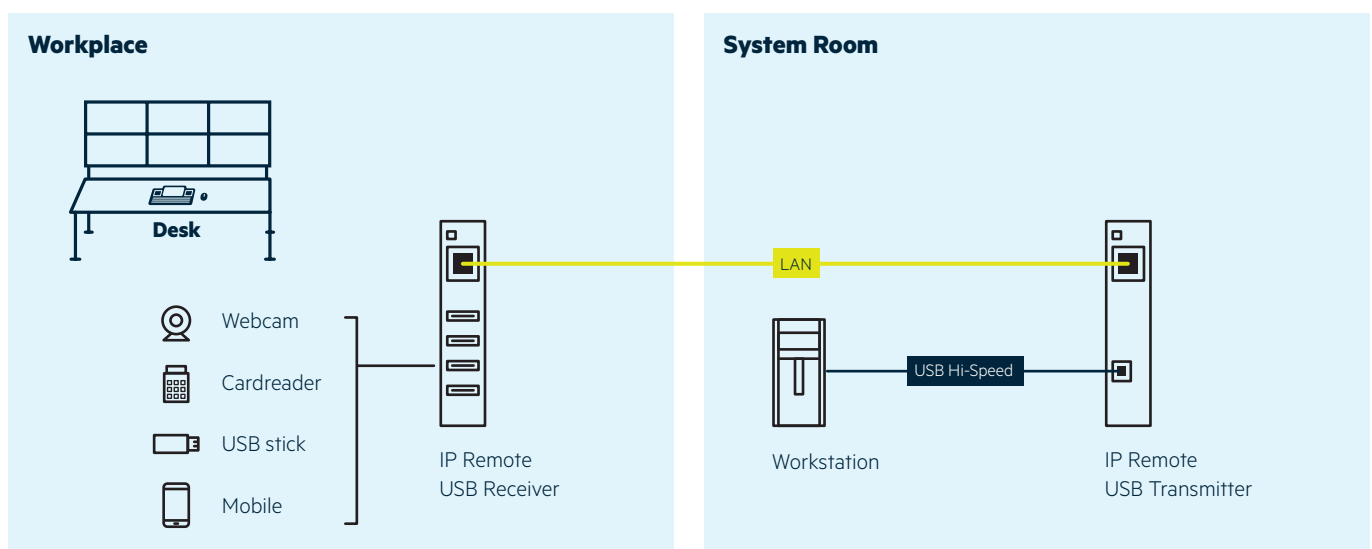

Application example: Switched Environment

WHY WEYTEC

**Add transparent
USB 2.0 HI-SPEED
to existing WEYTEC systems**

Workplace

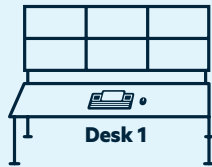

IP Remote
USB Receiver

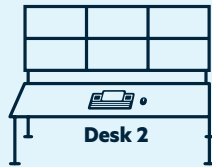

IP Remote
USB Receiver

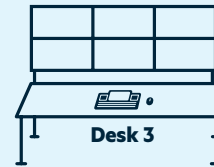
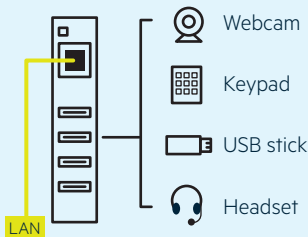

IP Remote
USB Receiver

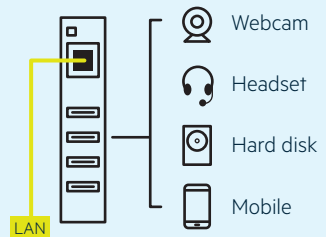

System Room

Gigabit Network
Switch

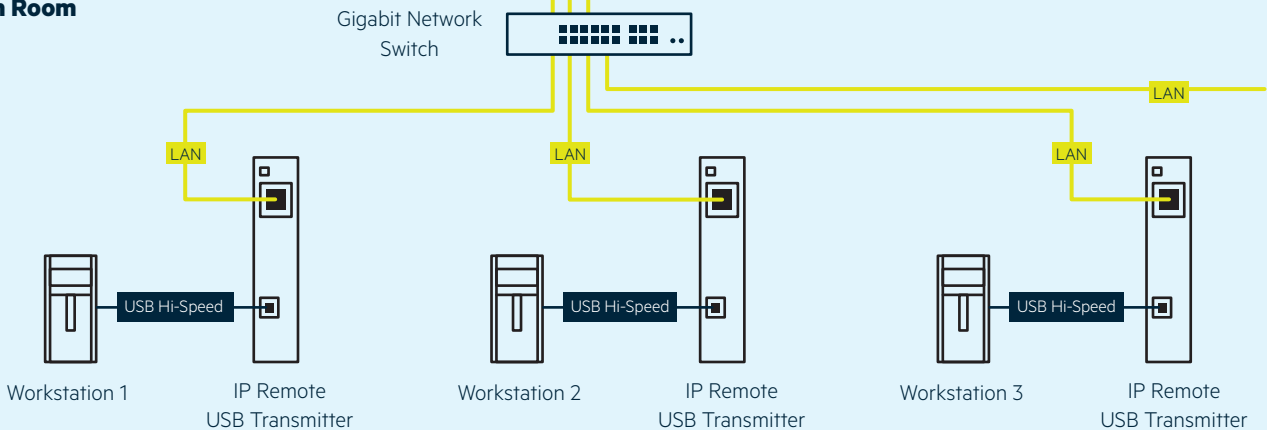

Available products

IP Remote USB II Transmitter

Product No. 24876T

IP Remote USB II Receiver

Product No. 24876R



USB	1 x USB 2.0 Type B Hi-Speed (transparent mode), maximum cable length 3 m	4 x USB 2.0 Type A Hi-Speed (transparent mode), maximum cable length 5 m
Network	1 x RJ45 1000 BASE-T, Cat 5e/6/7	
USB (Service Port)	1 x USB (2.0 Full Speed) Type Mini B 5 Pin	
IEEE 802.3ab	1000Base-T, Gigabit Ethernet	
Internet Protocol	IPv4 (fixed addressing), dedicated connection or via Ethernet switch/IP router ARP, ICMP Echo (ping), IGMPv3-Report (multicast)	
Mounting	Chassis and Boxes	